

IDTECH[®]

Value through Innovation

ID TECH VP7200 User Manual

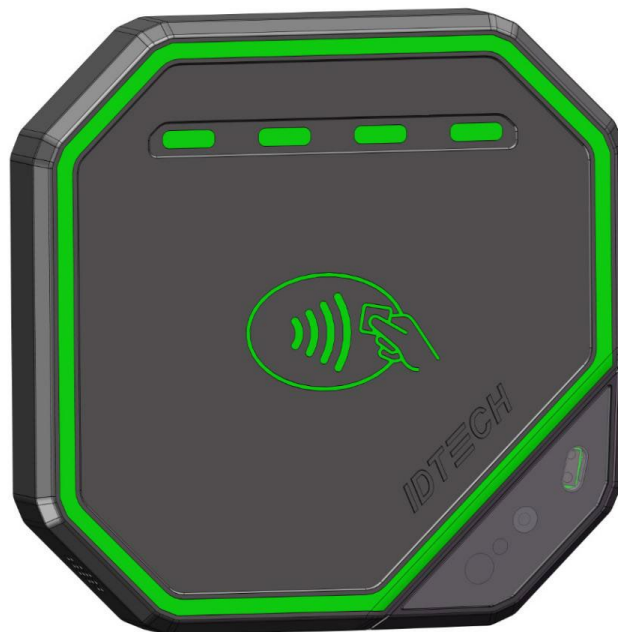

CE FC

80186500-001 Rev. A

30 May 2024

ID TECH

10721 Walker Street, Cypress, CA 90630-4720

Tel: (714) 761-6368 Fax (714) 761-8880

www.idtechproducts.com support@idtechproducts.com

Copyright© 2024 International Technologies and Systems Corporation. All rights reserved.

ID TECH
10721 Walker Street
Cypress, CA 90630 USA

This document, as well as the hardware and software it describes, is furnished under license and may only be used in accordance with the terms of such license. The content of this paper is furnished for informational use, subject to change without notice, and not to be construed as a commitment by ID TECH. ID TECH assumes no responsibility or liability for any errors or inaccuracies that may appear in this document.

Except as permitted by such license, no part of this publication may be reproduced or transmitted by electronic, mechanical, recorded, or any other method, or translated into another language or language form without the express written consent of ID TECH. ID TECH is a registered trademark of International Technologies and Systems Corporation. ID TECH and Value through Innovation are trademarks of International Technologies and Systems Corporation. Other trademarks are the property of the respective owner.

Warranty Disclaimer: The services and hardware are provided "as is" and "as-available," and the use of these services and hardware are at the user's own risk. ID TECH does not make, and hereby disclaims, any and all other express or implied warranties, including, but not limited to warranties of merchantability, title, fitness for a particular purpose, and any warranties arising from any course of dealing, usage, or trade practice. ID TECH does not warrant that the services or hardware will be uninterrupted, error-free, or completely secure.

FCC Regulatory Compliance

This device complies with Part 15 of the FCC Rules. Operation is subject to the following two conditions: (1) this device may not cause harmful interference, and (2) this device must accept any interference received, including interference that may cause undesired operation.

The user manual for an intentional or unintentional radiator shall caution the user that changes or modifications not expressly approved by the party responsible for compliance could void the user's authority to operate the equipment.

Note: The grantee is not responsible for any changes or modifications not expressly approved by the party responsible for compliance. Such modifications could void the user's authority to operate the equipment.

Note: This equipment has been tested and found to comply with the limits for a Class B digital device, pursuant to part 15 of the FCC Rules. These limits are designed to provide reasonable protection against harmful interference in a residential installation. This equipment generates uses and can radiate radio frequency energy and, if not installed and used in accordance with the instructions, may cause harmful interference to radio communications. However, there is no guarantee that interference will not occur in a particular installation. If this equipment does cause harmful interference to radio or television reception, which can be determined by turning the equipment off and on, the user is encouraged to try to correct the interference by one or more of the following measures:

- Reorient or relocate the receiving antenna.
- Increase the separation between the equipment and the receiver.
- Connect the equipment into an outlet on a circuit different from that to which the receiver is connected.
- Consult the dealer or an experienced radio/TV technician for help.

FCC RF Radiation Exposure Statement

This equipment complies with FCC radiation exposure limits set forth for an uncontrolled environment. To comply with FCC RF Exposure compliance requirements, this grant is applicable to only Mobile Configurations. The antennas used for the transmitter must be installed to provide a separation distance of at least 20cm from all persons and must not be co-located or operating in conjunction with any other antenna or transmitter.

ISED Warning statements

This device complies with Canada's licence-exempt RSSs. Operation is subject to the following two conditions: (1) This device may not cause interference; and (2) This device must accept any interference, including interference that may cause undesired operation of the device.

Le présent appareil est conforme aux CNR d'Industrie Canada applicables aux appareils radio exempts de licence.

L'exploitation est autorisée aux deux conditions suivantes : (1) l'appareil ne doit pas produire de brouillage, et (2) l'utilisateur de

l'appareil doit accepter tout brouillage radioélectrique subi, même si le brouillage est susceptible d'en compromettre le fonctionnement.

This equipment complies with IC RSS-102 radiation exposure limits set forth for an uncontrolled environment. This equipment should be installed and operated with a minimum distance of 20cm between the radiator and any part of your body.

Pour se conformer aux exigences de conformité CNR 102 RF exposition, une distance de séparation d'au moins 20 cm doit être maintenue entre l'antenne de cet appareil et toutes les personnes.

This Class B digital apparatus complies with Canadian ICES-003. Cet appareil numérique de la classe B est conforme à la norme NMB-003 du Canada.

CE Caution

RF Exposure

This equipment complies with CE radiation exposure limits set forth for an uncontrolled environment. This equipment should be installed and operated with minimum distance of 20cm between the radiator and your body.

EU DECLARATION OF CONFORMITY



Hereby, ID TECH declares that the radio equipment type VP7200 is in compliance with Directive 2014/53/EU. The full text of the EU declaration of conformity is available at the following Internet address: <https://idtechproducts.com/> The product is so constructed that it can be operated in at least one Member State without infringing applicable requirements on the use of radio spectrum.

Notice for Operating Frequency and Output Power:

Feature	VP7200
NFC	<123.9dBuV/m at 3m (Measured Value)
2G (dBm)	GSM900: <33 GSM1800: <30
3G (dBm)	Band I: <24 Band VIII: <24
4G (dBm)	Band 1/20: <23 Band 3: <23 Band 7: <23 Band 8: <23 Band 28: <23

Cautions and Warnings

	Caution: The VP7200 should be mounted 1-2 feet away from other VP7200s. Can be adjusted based on lane setup.
	Warning: Avoid close proximity to radio transmitters which may reduce the capability of the reader.

Revision History

Date	Rev	Changes	By
05/30/2024	A	Initial release.	CB

Table of Contents

1. OVERVIEW	7
1.1. Universal SDK	7
1.2. Encryption	7
2. FEATURES	8
2.1. Certifications and Approvals	9
2.2. Regulatory	9
4. VP7200 SPECIFICATIONS	10
4.1. Power Consumption	11
4.1.1. Working mode.....	11
4.1.2. Low Power Mode.....	11
4.2. VP7200 LTE, SAM, and SIM Setup	11
5. VP7200 LED AND SOUND STATE INDICATORS	12
5.1. Tamper and Failed Self-Check Indicators	13
7. VP7200 INSTALLATION	14
7.1. Parts List	14
7.2. VP7200 Interface Connectors	14
7.3. Mounting the VP7200.....	15
7.4. Connecting to Power	16
7.5. Communication via USB	16
7.6. Connecting to the Data Port.....	17
7.7. Installation Checklist	17
7.7.1. Visual Inspection	17
7.7.2. Installation Procedures.....	17
7.7.3. Recommendations.....	18
7.8. Using the VP7200 to Make a Purchase	19
7.8.1. Presenting Cards or NFC Phones	19
7.8.2. Making a Purchase.....	19
7.9. Installation Points	20
8. RF INTERFERENCE.....	21
9. FIRMWARE UPGRADE	22
9.1. Preparation.....	22
9.2. Uploading Firmware for USB	22
9.3. Updating K81 Bootloader file.....	23
9.4. Updating K81 Firmware	24
9.5. Updating K81 Project Tree Firmware.....	25
9.5.1. Determining the Correct Firmware File to Use.....	25
9.5.2. Updating the Project Tree Firmware.....	26
9.6. Upgrading 1050 uniFWApp file	27
10. TROUBLESHOOTING.....	28
11. FOR MORE INFORMATION	30

1. Overview

The ID TECH VP7200 is a compact, standalone contactless reader, designed to support contactless EMV transactions based on ISO 18092, ISO 14443 Type A/Type B/MiFare compatible cards, fobs and tags, as well as NFC phones. The VP7200 is a single piece device including controller and antenna.

The VP7200 supports USB and serial RS-232 host communication using the NEO 3 protocol defined in the *NEO 2 Interface Developers Guide*. This comprehensive guide describes all the firmware commands and other features available in NEO 3-series devices; it is the authoritative source for technical information of interest to systems integrators. (Contact your ID TECH representative to obtain a copy of this guide, which is available only on request.) See this guide when controlling the VP7200 through firmware commands sent directly over a serial port.

1.1. Universal SDK

A feature-rich Windows-based Universal SDK is available to aid rapid development of applications that talk to VP7200. The SDK is available for the C# language on Windows and comes with sample code for demo apps. To obtain the SDK and other useful utilities, demos, and downloads, be sure to check the Downloads link on the [ID TECH Knowledge Base](#) (no registration required).

1.2. Encryption

VP7200 supports industry-standard Triple DES or AES encryption, with DUKPT-based key management (per ANSI X9.24). Encryption can be configured to occur with a data variant as desired. ID TECH operates a certified Key Injection Facility, capable of injecting your unit(s) with any required keys. Consult your ID TECH representative to learn about all available options involving key injection.

2. Features

The VP7200 supports the following transaction types:

- ISO/IEC 14443 Type A and B
- ISO 18092
- ISO 21481 (PCD & NFC)
- Suitable for transit, kiosks, parking and various other unattended and attended verticals.
- Consumer Intuitive: Equipped with LEDs and sound to provide visual and audible cues to enable smooth and seamless transactions.
- Secure: Provides highly secure transactions whether financial, pre-paid, loyalty, or gift cards. Data is encrypted at the time of the transaction and never travels in clear-text form.
- Self-contained antenna
- VP7200 is certified with Visa Ready for Transit



This document assumes that users are familiar with their host systems and all related functions.

2.1. Certifications and Approvals

VP7200 supports the following contactless payment applications and mobile payments:

- American Express ExpressPay 4.1
- Discover DPAS 2.0
- Felica
- Interac Flash v1.8
- JCB
- MasterCard PayPass/MChip 3.1.4
- UPI
- Visa VCPS 2.2 and VISA VCTKS 1.1
- Mifare
- Apple Pay, Google Pay, Samsung Pay, & other Mobile Wallets
- Apple VAS & Google SmartTap mobile Loyalty Programs
- AT&T Trendi
- PTCRB/GCF Report

2.2. Regulatory

- CE Mark
- UL certified
- ROHS2 and REACH
- TQM Certification
- Japan Telec/VCCI

4. VP7200 Specifications

Hardware	
MTBF	500,000 hours based on Telcordia Technologies SR-332 modeled at 40° C.
Transmitter Frequency	13.56 MHz +/- 0.01%
Transmitter Modulation	ISO 14443-2 Type A Rise/Fall Time: 2-3 µsec. Rise, < 1 µsec fall ISO 14443-2 Type B Rise/Fall Time: < 2 µsec. each; 8% - 14% ASK ISO 18092 ISO 21481 (PCD & NFC)
Receiver Subcarrier Frequency	847.5 KHz
Receiver Subcarrier Data	ISO 14443-2 Type A: Modified Manchester ISO 14443-2 Type B: NRZ-L, BPSK ISO 18092 ISO 21481 (PCD & NFC)
Typical Read Range	4-6 cm (1.5 to 2.3 inches)
Physical	
Length	68 mm (2.68 inches)
Width	68 mm (2.68 inches)
Depth	11.5 mm (0.45 inches)
Environmental	
Operating Temperature	-30° C to 70° C (-13° F to 158° F), max change of 10° C per hour
Tamper Detection Temperature Range	-45° C to 120° C (-49° F to 248° F)
Storage Temperature	-30° C to 85° C (-22° F to 185° F) [non-condensing]
Operating Humidity	10% to 90% non-condensing, maximum 95%
Storage Humidity	10% to 90% non-condensing, duration 3 months
Transit Humidity	5% to 95% non-condensing, duration 1 week
Operating Environment	Water resistant for indoor and outdoor use
IK Rating	IK 7
IP Rating	IP 65
ESD	+/-8KV Contact and +/- 12KV Air
Electrical	
Reader Input Voltage	+5V (USB port-powered; RS-232 requires power supply)
Working Current Rated power	<2A <10w
Maximum field strength Battery (for real-time clock)	2.6 dBuA/m at 3m CR2032 20mm x 3.2mm, 230mAh ("coin" battery), lifetime 5 years

4.1. Power Consumption

Note the following information about VP7200 power consumption.

4.1.1. Working mode

- Contactless transaction mode maximum power consumption is <2A/5V.
- When the VP7200’s RF is inactive due to no connection to the host device, the maximum power consumption is <200mA/5V.

4.1.2. Low Power Mode

VP7200 low power mode is only supported with RS-232 5VDC input. Note that low power mode is NOT supported via USB.

- Standby mode power consumption is <TBD/5V. VP7200 units can wake up via RS-232 with a wake-up time of <1s.
- Sleep mode power consumption is <TBD/5V. VP7200 units can wake up via RS-232 with a wake-up time of <8s.

4.2. VP7200 LTE, SAM, and SIM Setup

The tables and diagram below illustrate VP7200 LTE, SAM, and SIM connections.

P/N	Region/Operator	SIM card slot	Antenna connection
ID72-818D	North America	SIM1/SIM2	Main/DIV
ID72-838D	EMEA	SIM1/SIM2	Main/DIV
ID72-868D	Japan	SIM1	Main

P/N	SAM card slot				SIM card slot	
	SAM1	SAM2	SAM3	SAM4	SIM1	SIM2
ID72-818D	✓	✓	X	X	✓	✓
ID72-838D	✓	✓	X	X	✓	✓
ID72-868D	✓	✓	X	X	✓	X
ID72-808D	✓	✓	✓	✓	X	X

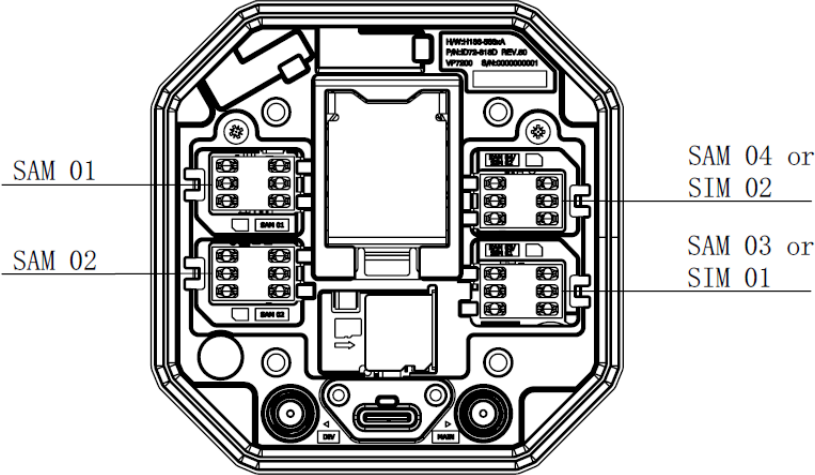

5. VP7200 LED and Sound State Indicators

The VP7200 uses the following LEDs and sounds to indicate various statuses, including power management, transactions, and security.

Device State	LED1	LED2	LED3	LED4	Beeper ¹
Device FW, certificates, or keys self-test failed.	○ off	○ off	○ off	● blink	Beeps
Device Tampered	○ off	○ off	○ off	● blink	Beeps
Device Deactivated	○ off	○ off	○ off	● blink	Beeps
Device Activated ²	○ off	○ off	○ off	● on	Off
Device Key Missing ³	● blink	● blink	● blink	● blink	Off
Ready for Transaction	● blink	○ off	○ off	○ off	Off
Transaction Started ⁴	● on	○ off	○ off	○ off	Off
Transaction Successful ⁵	● on	● on	● on	● on	Beeps Once
Transaction Failed	○ off	○ off	○ off	○ off	Beeps Twice

¹ Note that “beeps” indicates constant beeping unless the description includes a specific number of beeps (such as “twice”).

² The device has loaded certificates successfully and is activated.

³ The device only has LCL-KEK; the required key is not injected.

⁴ The transaction has started and the device is waiting to read a card.

⁵ LEDs remain on for 1000ms.

5.1. Tamper and Failed Self-Check Indicators

The VP7200 displays the following indicators when it has been tampered or has any of the other following internal issues, such as an expired certificate, missing key, or similar fault discovered during a self-check.



Indicator		Tampered Status
	LED	LED4 blink Red
	Buzzer	Alarm tone

7. VP7200 Installation

This section provides information on how to install the VP7200 on a kiosk.

7.1. Parts List

Verify that you have the following hardware for the installation of the VP7200:

- VP7200.
- Cables (sold separately)
 - RS-232: Use a cable with **P/N to 80185224-001** or equivalent 5VDC powered cable.
 - USB: Use a USB-A to USB-C cable with **P/N 80186214-001** (the VP7200 unit, in this case, would be port-powered).
 - Ethernet cable: **P/N 80185225-001**; using an ethernet cable requires 5VDC power adapter **P/N AC0005R-28**.

7.2. VP7200 Interface Connectors

The diagram below displays interface connectors for VP7200 readers.

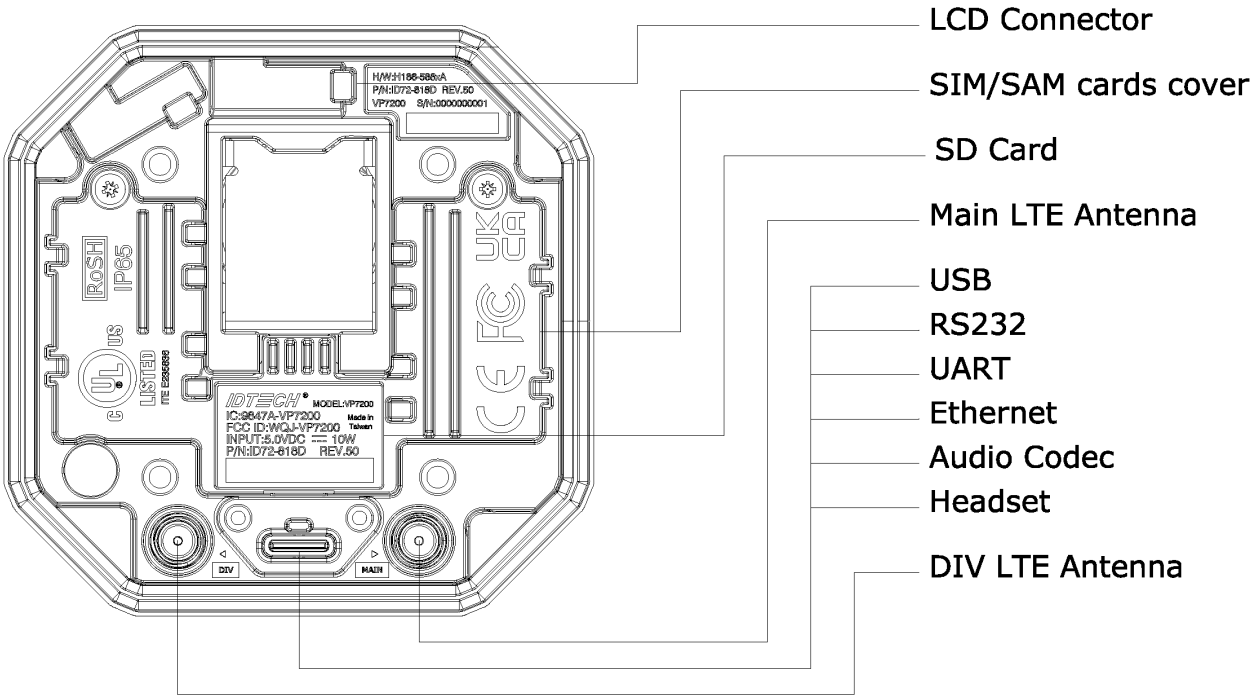

7.3. Mounting the VP7200

To optimize performance, install VP7200 readers away from or in front of any metal surfaces or materials that have metallic content, which can interfere with the RF field. VP7200 readers perform optimally when mounted away from metal surfaces.

Note: For safety reasons, make sure to mount the VP7200 at a height no greater than two meters from the floor.

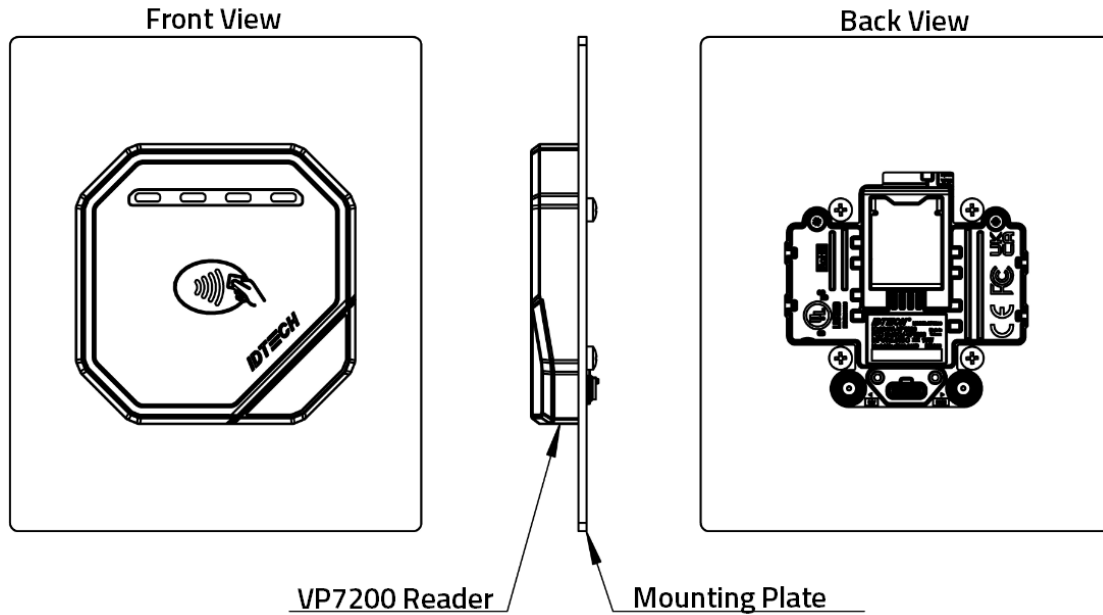

Note: The VP7200 is post-compatible with Kiosk III, Kiosk IV, and VP7200 dimensions. Posts are 36mm apart in the lengthwise direction and 32mm apart widthwise. See the drawing below.

Use the following instructions to mount the VP7200 on the exterior of a kiosk structure:

- Using the Drill Template below, locate and mark the (4) 3.5mm (0.138 inch) mounting holes.

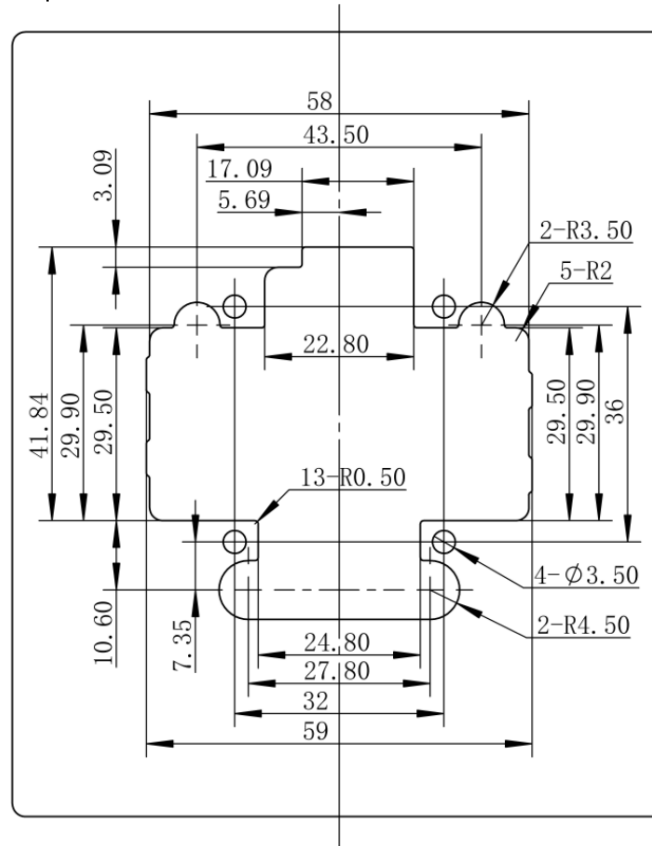

- Using the Drill Template, locate and mark the 9.95mm*15.77mm(0.392inch*0.621inch) rectangle hole (used for connecting the USB-type C cable to the VP7200).
- Align the four M3 screws with the mounting holes and attach the VP7200 to the outside surface.
- Use the four screws to secure the VP7200 to the outside surface of the kiosk. Make sure to tighten the screws securely so that the VP7200 does not move on the outside surface of the kiosk.
- Route the end of the USB-Type C cable through the rectangle hole into the kiosk and tighten the two M2 screws in the over mode of the USB-Type C cable to ensure the cable is locked reliably.

7.4. Connecting to Power

The VP7200 can be powered via the USB port; if the unit is connected via RS-232, use a power supply with P/N AC0005R-28.

7.5. Communication via USB

The PID is 4700 (hex) and the VID is 0ACD (hex).

7.6. Connecting to the Data Port

The VP7200 has three data connection options: USB, RS-232, and Ethernet through the USB-C connector.

USB-C Connector

PIN#	Function	PIN#	Function
A1	GND	B12	GND
A2	RS232_TX→	B11	RS232_RX←
A3	RS232_RTS→	B10	RS232_CTS←
A4	VBUS	B9	VBUS
A5	CC1	B8	LINEOUT_R
A6	USB_DP	B7	UART_TX→(3.3V IO)
A7	USB_DN	B6	UART_RX←(3.3V IO)
A8	LINEOUT_L	B5	MIC_DET
A9	VBUS	B4	VBUS
A10	ETHERNET_RXN	B3	ETHERNET_TXN
A11	ETHERNET_RXP	B2	ETHERNET_TXP
A12	GND	B1	GND

7.7. Installation Checklist

When installing VP7200 units, be sure to verify the following items.

7.7.1. Visual Inspection

Before installing a VP7200:

- Visually inspect the reader for any modifications on the plastic housing.
- Check the security labels over the screws to verify the reader has not been tampered with.
- Power up the reader and check for any flashing LEDs and beeps that indicate tampering. Refer to [Tamper and Failed Self-Check](#) indicators for specific information.

7.7.2. Installation Procedures

After visually inspecting the VP7200, follow these guidelines when integrating the reader to your system:

- Insert any Security Access Modules into the SAM sockets.
- For additional memory expansion, insert any microSD card into the uSD socket.
- If your unit supports LTE radio, insert your network SIM into the SIM sockets.
- Close the cover and install the unit in its housing using four screws. **Note:** Do not overtighten the screws.
- If the display module is supported, insert the display module flex into the optional LCD connector.

- Insert the communication/power cable into the USB-C connector and tighten the locking screws (if provided).
- Power on the whole system and check the unit's operations.

7.7.3. Recommendations

Additionally, follow these recommendations after installation:

- Periodically inspect the system for any tampering and insertion of electronic bugs.
- Look for the latest updates on the manual or firmware on the ID TECH website.
- See the [Using the VP7200 to Make a Purchase](#), [Installation Points](#), and [Firmware Upgrade](#) sections below for additional information about verifying device functionality and performing maintenance.

7.8. Using the VP7200 to Make a Purchase

7.8.1. Presenting Cards or NFC Phones

The VP7200 allows for credit/debit card purchases using Contactless (NFC) technology. Present the card/phone in close proximity to the front portion of the antenna module. Present the card/phone so that maximum surface area is parallel to the antenna module as shown below.



The antenna should beep, and the four green LEDs should illuminate in sequence, then all will illuminate together, briefly (750 msec), to indicate a successful test.

This tests the VP7200's ability to read the Contactless test card. If unsuccessful, there will be no reaction from the reader. If you use a test card and the VP7200 antenna is attached to the VP7200 Controller, a dummy transaction can be tested. The transaction will not be authorized and will come back with a response but will at least test for end-to-end connectivity.

7.8.2. Making a Purchase

After the transaction has been entered on the kiosk control panel, the customer should present his or her card/fob/phone in close proximity with the device so that maximum surface area is parallel to the antenna.

- A single beep and all four LEDs briefly flashing indicates the card/fob/phone has been read correctly.

7.9. Installation Points

- The VP7200 is **NOT** designed to be mounted on a metal surface and in close proximity to any internal motors and electrical devices that may be operating inside the kiosk. However, the VP7200 is susceptible to RF and electromagnetic interference. ***It is important that the unit not be mounted near (within 3 or 4 feet) large electric motors, computer UPS systems, microwave transmitters (Wi-Fi routers), anti-theft devices, radio transmitters, communications equipment and so on.***
- ***Close proximity of metal to the RF-emitting end of the antenna can greatly reduce the range of the antenna. See the precautions described in Flush Mounting the VP7200 Antenna.***
- Make sure to install the SAM/SIM card cover before checking SAM/SIM cards functions.
- Tie all cables neatly with nylon cable-ties and route them so that they are inaccessible and invisible to customers. Label the cable ends, host, ID TECH and power, to simplify connection testing or component replacement.
- Test the VP7200 installation using a test card to perform an end-to-end transaction (the same as an actual purchase on the Kiosk). The kiosk display panel (if it exists) should display "Requesting Authorization." Even if the transaction is declined (as it should be with a test card), it will prove connectivity all the way through the system. If possible, the store manager or some other responsible party should test each VP7200 on a regular basis (perhaps at the start of each day or at least once per week) with a test card to ensure continued operation and functionality. If the kiosk is rebooted on a regular basis (such as every night), it is important to test the contactless reader as soon as possible afterwards to ensure continued communication to the kiosk host.

8. RF Interference

Q. Why do I need to know about RF interference?

A. Contactless payment uses radio frequency technology to send card data to a contactless terminal reader.

Q. How can RF interference affect contactless payment?

A. RF interference can cause data errors. If RF interference is present, contactless payment devices may operate intermittently or inconsistently.

Q. Where does RF interference come from?

A. Radio frequency interference (RFI) can originate from a wide number of sources at the point-of-sale (POS). Some examples of sources of RF energy and RF interference include:
AM/FM radio and TV transmitters 2-way radios, pagers
Mobile telephones Power lines, transformers Medical equipment Microwaves
Electromechanical switches

Q. What should I do if I suspect RF interference exists in my environment?

A. Begin by inspecting your environment for possible sources of RF interference.

Q. Do equipment manufacturers test their devices for RF interference?

A. Electronic equipment is tested for RFI sensitivity by the manufacturers. These tests are performed in a controlled laboratory environment and will often not replicate the types of devices that would be encountered in your point-of-sale (POS) environment.

Q. What RF levels will impact RF operations?

A. Factors that can cause RF interference vary case-by-case. There are no set rules defining a single RF level that will cause RFI. RFI depends on the sensitivity of the equipment under consideration, or how low an interpreting signal can be in the presence of the equipment and cause problems. Equipment can be particularly sensitive to very low signal levels of one frequency and yet be quite immune to high signal levels of another frequency - so frequency is an important factor. Some electronic system components are internally shielded and have a very high immunity to interference; but generally, most equipment has not been so engineered.

9. Firmware Upgrade

The VP7200 can be upgraded using USB interfaces. Contact your ID TECH representative to obtain the necessary software.

9.1. Preparation

To update the new firmware, you will need:

- PC with an available USB port with the [ID TECH Universal SDK Demo application](#) installed.
- A VP7200 reader with a Multi Cable (use the USB port labeled **Data**).
- Firmware files extracted to your computer; contact your ID TECH representative to receive the following:
 - K81 Bootloader file
 - K81 FWApp file
 - K81 Project Tree file
 - 1050 uniFWApp file (including the Bootloader)

9.2. Uploading Firmware for USB

1. Check and confirm the device is correctly connected to the power source and USB connection.
2. Open the Universal SDK Demo app; the app automatically scans for devices.

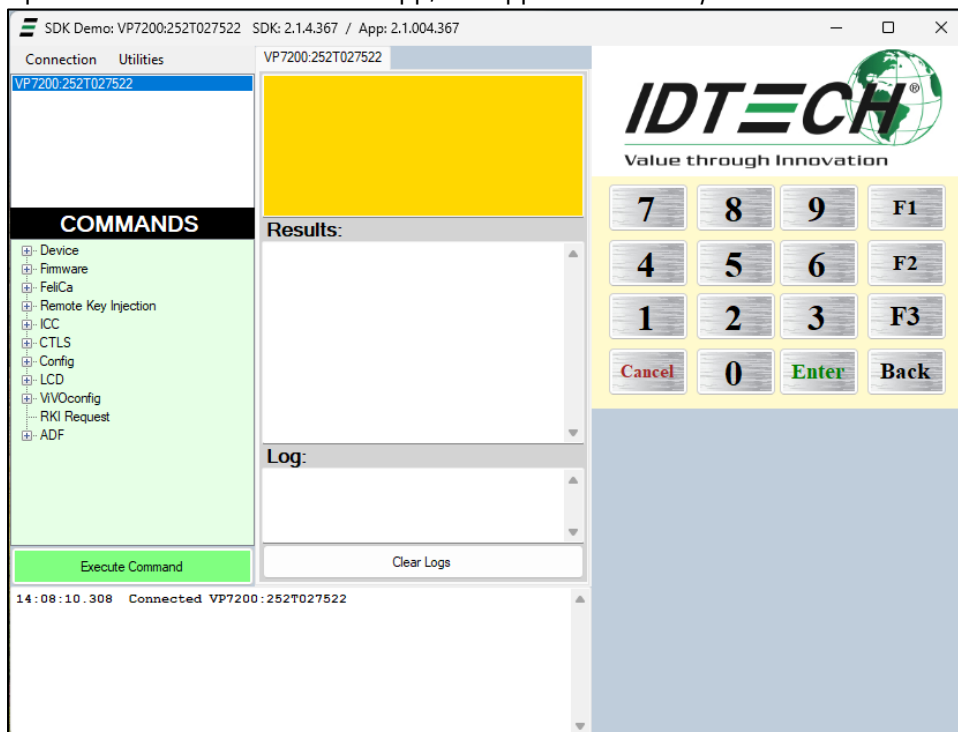

3. Under **Commands**, open the **Firmware** tree.

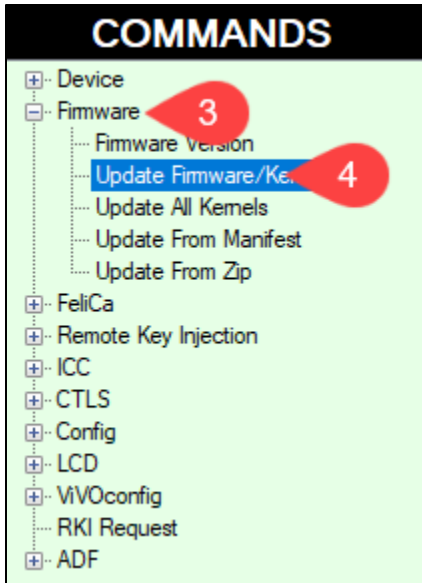

4. Select **Update Firmware/Kernels**; the USDK Demo app opens a Firmware Type dialog.

9.3. Updating K81 Bootloader file

1. In the **Firmware Type** dialog, enter **252** and select **OK**.

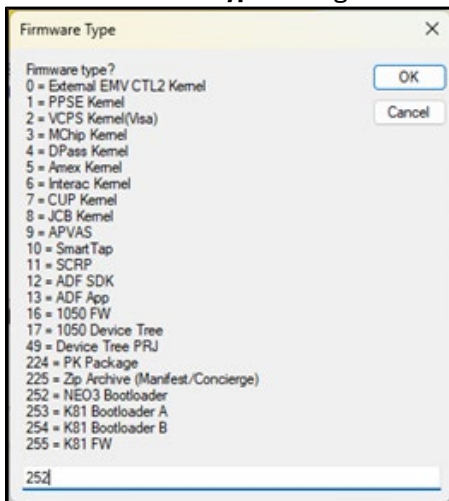

2. Select the K81 Bootloader file from the extracted location and select **Open**.

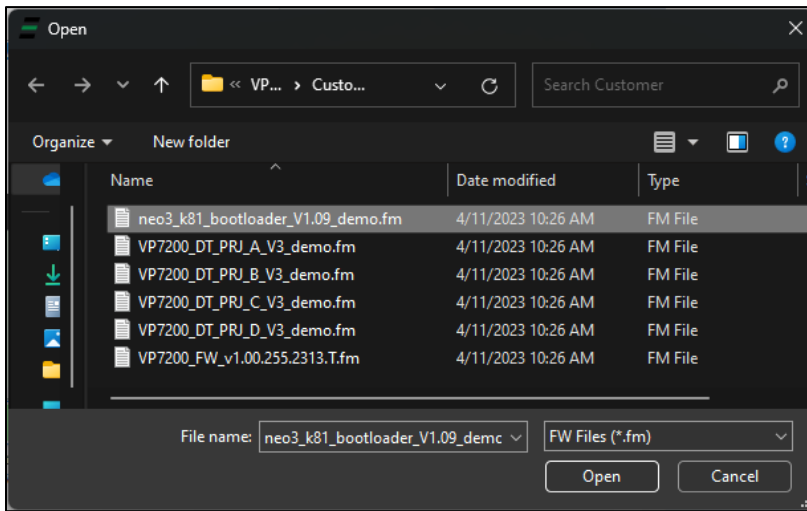

3. The Universal SDK Demo app will update the reader's firmware; this process may take several minutes.
4. When the process is complete, the **Results** pane displays **Firmware Update Successful** and **Firmware Update Process Completed with Success**.

9.4. Updating K81 Firmware

1. In the **Firmware Type** dialog, enter **255** and select **OK**.

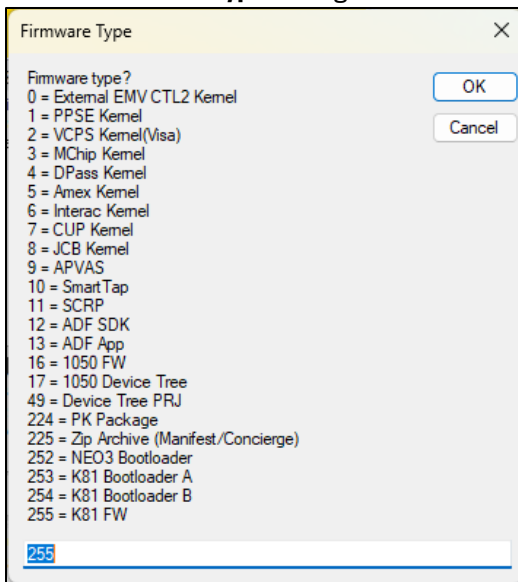

2. Select the K81 **VP7200_FW** file and select **Open**.

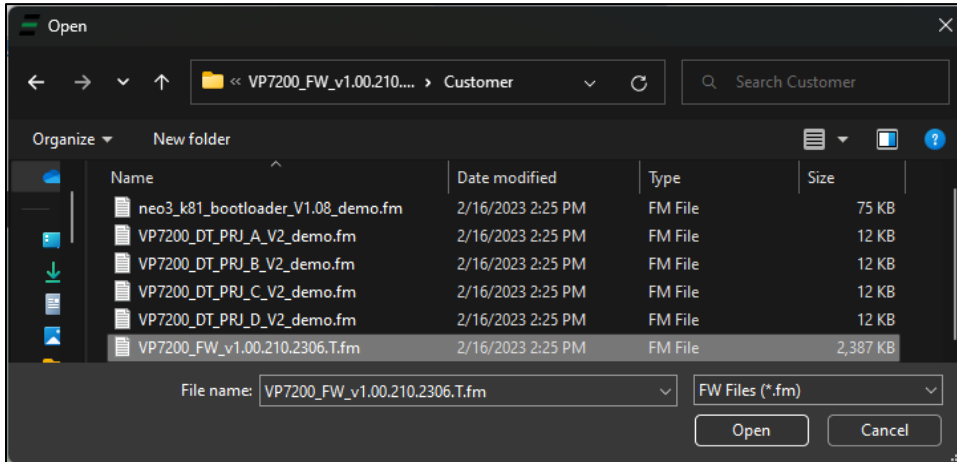

3. The Universal SDK Demo app will update the reader’s firmware; this process may take several minutes.
4. When the process is complete, the **Results** pane displays **Firmware Update Successful** and **Firmware Update Process Completed with Success**.

9.5. Updating K81 Project Tree Firmware

The section below provides steps for updating the K81 Project Tree firmware.

9.5.1. Determining the Correct Firmware File to Use

Note that VP7200 readers use different **firmware project versions** depending on their model numbers, as listed in the table below:

Model	ID72-818D	ID72-838D	ID72-868D	ID72-808D	ID72-000D
	ID72-818	ID72-838	ID72-868	ID72-808	ID72-000
Secure DT model	T or S	T or S	T or S	T or Z	T or S
Project DT model (1050)	A	A	B	C	D
Project DT model (K81)	A	A	B	C	D

For example, referencing the table above, a reader with a model number of **ID72-818** (or ID72-818D for demo readers) uses version A in the product tree. Firmware files have these project version designations listed in their file names as provided in firmware updates:

Name	Date modified	Type
VP7200_Ext_DT_PRJ_A_V4_demo.fm	4/11/2023 10:26 AM	FM File
VP7200_Ext_DT_PRJ_B_V4_demo.fm	4/11/2023 10:26 AM	FM File
VP7200_Ext_DT_PRJ_C_V4_demo.fm	4/11/2023 10:26 AM	FM File
VP7200_Ext_DT_PRJ_D_V4_demo.fm	4/11/2023 10:26 AM	FM File
VP7200_Ext_FW_v1.00.205.2313.T.fm	4/11/2023 10:26 AM	FM File

9.5.2. Updating the Project Tree Firmware

1. In the **Firmware Type** dialog, enter **49** and select **OK**.

Firmware Type

Firmware type?

- 0 = External EMV CTL2 Kernel
- 1 = PPSE Kernel
- 2 = VCPS Kernel(Visa)
- 3 = MChip Kernel
- 4 = DPass Kernel
- 5 = Amex Kernel
- 6 = Interac Kernel
- 7 = CUP Kernel
- 8 = JCB Kernel
- 9 = APVAS
- 10 = SmartTap
- 11 = SCRP
- 12 = ADF SDK
- 13 = ADF App
- 16 = 1050 FW
- 17 = 1050 Device Tree
- 49 = Device Tree PRJ
- 224 = PK Package
- 225 = Zip Archive (Manifest/Concierge)
- 252 = NEO3 Bootloader
- 253 = K81 Bootloader A
- 254 = K81 Bootloader B
- 255 = K81 FW

49

OK

Cancel

2. Select the K81 **VP7200_FW** file for your [VP7200's model number](#) and select **Open**.

Name	Date modified	Type
VP7200_Ext_DT_PRJ_A_V4_demo.fm	4/11/2023 10:26 AM	FM File
VP7200_Ext_DT_PRJ_B_V4_demo.fm	4/11/2023 10:26 AM	FM File
VP7200_Ext_DT_PRJ_C_V4_demo.fm	4/11/2023 10:26 AM	FM File
VP7200_Ext_DT_PRJ_D_V4_demo.fm	4/11/2023 10:26 AM	FM File
VP7200_Ext_FW_v1.00.205.2313.T.fm	4/11/2023 10:26 AM	FM File

3. The Universal SDK Demo app will update the reader's firmware; this process may take several minutes.
4. When the process is complete, the **Results** pane displays **Firmware Update Successful** and **Firmware Update Process Completed with Success**.

9.6. Upgrading 1050 uniFWApp file

1. In the **Firmware Type** dialog, enter **16**, then hold the **Shift** key and select **OK**.
2. In the **Block Size** dialog, enter **2048** (*not 1024*) and select **OK**.

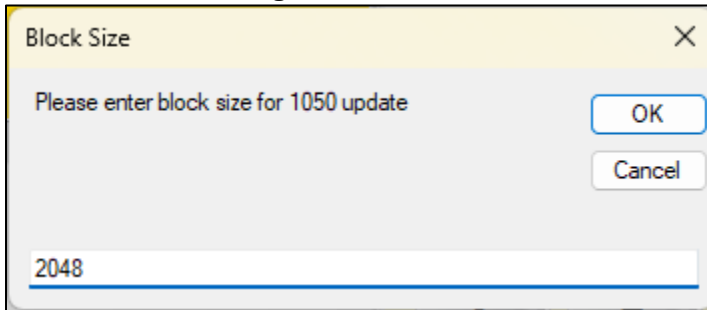

3. Select the 1050 **VP7200_Ext_FW** file and select **Open**.

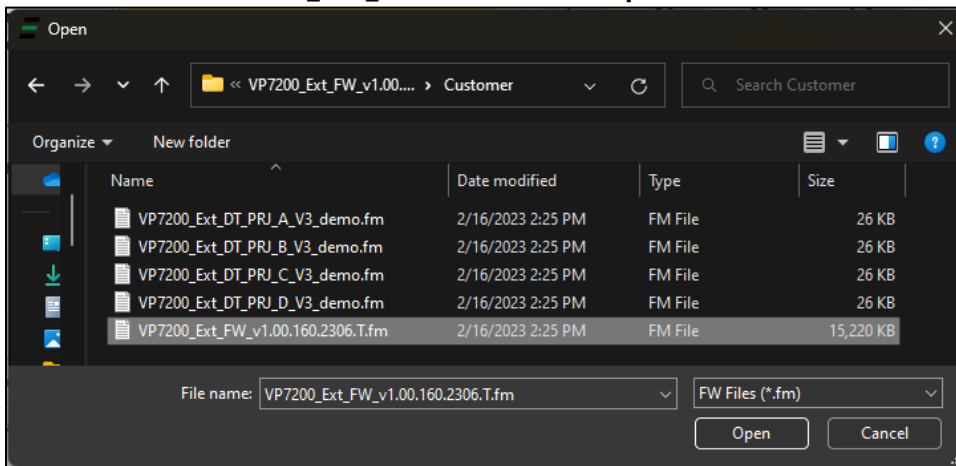

4. The Universal SDK Demo app will update the reader's firmware; this process may take several minutes.
5. When the process is complete, the **Results** pane displays **Firmware Update Successful** and **Firmware Update Process Completed with Success**.

10. Troubleshooting

VP7200 readers are reliable and easy to troubleshoot. The components that may require troubleshooting include the power supply, the reader itself, and the serial cable. ***If you are unable to resolve the problem, contact support@idtechproducts.com (sending an e-mail to this address will automatically open a support ticket).***

Symptom	Possible Cause	Remedy
General Issues		
Reader does not appear to be powered on (no LEDs are lit). Note that when the unit is expecting a transaction, the first LED (on the left) will illuminate continuously. Otherwise, in the idle state, it will blink.	<ul style="list-style-type: none"> • Reader not powered on or incorrect voltage. • Improper use of internal power supply provided by the kiosk. 	<ul style="list-style-type: none"> • Check cable connections. • Verify that power is on and correct voltage and current are present. • Make sure that the correct pins are utilized. • Make sure that the power provided is within the specified range of the VP7200 reader. • Make sure that the correct polarity is observed. • For more information, refer to the Input Voltage under the Electrical specification section. • Replace the VP7200.
Reading Cards/Phones		
First LED is lit, but beeper is not audible when card/fob presented.	<ul style="list-style-type: none"> • Card/fob/phone not properly presented. • RF interference. • Unsupported card used. • Wrong firmware (contact your local support representative). 	<ul style="list-style-type: none"> • Present card/fob/phone closer to the antenna, and ensure it is parallel to the face of the reader. • Verify that the card/fob/phone is valid/current. • Verify that metal is not interfering with the antenna. • Test with "ViVOcard Contactless Test Card" • part number 241-0015-03 Rev A. • Try a different card/fob. • Check to see if card/fob is damaged. • Verify that correct firmware is loaded on reader (local support representative only). • Power cable plug is fully inserted. • Replace the VP7200.
Some cards/fobs read, but not all.	<ul style="list-style-type: none"> • Possible bad card/fob. • Unsupported card used. • Wrong firmware (contact your local support representative). 	<ul style="list-style-type: none"> • Check to see if card/fob is damaged. • Verify that correct firmware is loaded on reader (local support representative only). • Present the card in a different orientation.

Communication to Kiosk		
No data is received, or data is garbled.	<ul style="list-style-type: none"> Faulty or incorrect cable connections. 	<ul style="list-style-type: none"> Check that the cable connection is secure and in the correct port on the VP7200.
Load Firmware		
Firmware loading software indicates "open RS232 failed"	Device is not well connected to PC or other software is using serial interface	<ul style="list-style-type: none"> Check the cable connection Close other software which is using serial interface
Firmware loading software indicate "Load firmware failed"	Device is not well connected to PC	<ul style="list-style-type: none"> Check the cable connection
Firmware loading software indicates "Send Command failed"	Bootloader firmware in device is destroyed	<ul style="list-style-type: none"> contact your local support representative to reload manufacture firmware

11. For More Information

- To learn more about the VP7200 and other ID TECH products, visit the [ID TECH Knowledge Base](#).
- Visit us online at <http://idtechproducts.com>.
- Find more Tech Support resources at the [ID TECH Tech Support home page](#).